

Legend® Series

Positive Displacement Blowers
& Vacuum Pumps



GARDNER
DENVER

1859

2009

SESQUICENTENNIAL

GD
GARDNER DENVER™

Experience Proven Results™

Sutorbilt Legend Series

Setting the Industry Standard

The Gardner Denver Sutorbilt® Legend® line of rotary positive displacement lobe blowers and vacuum pumps are the result of more than 150 years experience in the design, manufacture and support of superior industrial equipment.

- Available in 20 sizes with 4 different configurations
- The Legend Series delivers
 - Pressure to 15 psig
 - Vacuum to 16” Hg
 - Flows to 3,015 cfm

Why the Sutorbilt line of blowers and vacuum pumps earned the name “Legend”

- Backed by the most experienced and trusted distributor network in the industry
- Every Sutorbilt Legend blower/vacuum pump is built under rigid ISO 9001:2000 quality standards
- Each Legend is individually tested to meet rigorous performance specifications
- Requested by leading Original Equipment Manufacturers (OEMs) worldwide for a wide range of applications, due to the ability to customize the Legend to their specifications while meeting strict performance requirements
- A Legend is at the heart of an ever-expanding variety of air solutions working every minute of every day around the globe
- Dual Splash Lubricated and Quiet Series (for up to 5 dBA reduction) are available



Proven Performance. Global Applications. Local Support.

QUIET OPERATION

The sound data shown below compares the Legend (red) and a comparably sized blower (green) operating at 3,275 rpm and 12 psig.

- Improved blower design reduces the sound pressure output of the Legend blower
- Typical reduction is 3 dBA which represents 50% less noise than the competition

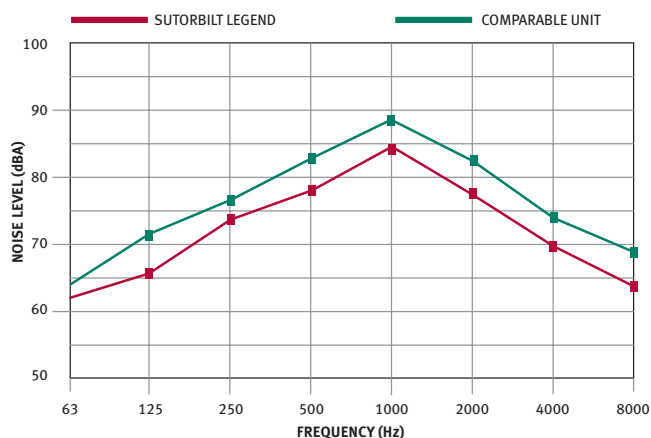

SUPERIOR LOCAL SALES AND SERVICE

- Extensive network of authorized Gardner Denver/ Sutorbilt distributors
- Offers the most convenient local sales and service support in the industry
- Factory trained professionals are experts in blower/ vacuum pump technology
- Providing system installation guidance, troubleshooting and optimization recommendations for new or existing applications

EVEN A “LEGENDARY” WARRANTY

Every Sutorbilt Legend Series blower/vacuum pump is covered by a “Legendary” warranty:

- **24 months** from the date of shipment or
- **18 months** from the date of installation, whichever occurs first

INDUSTRY	APPLICATION
Aquaculture	Aeration
Cement & Lime	Fluidization & Conveying
Chemical	Vacuum Processing & Conveying
Coal Bed/Landfill	Methane Gas Recovery
Dairy	Automated Milking
Dry Bulk Hauling	Trailer Unloading & Aeration
Environmental Services	Sewer Cleaning & Portable Restroom Services
Industrial	Material Vacuuming
Milling & Baking	Blending & Conveying
Oil & Gas	Gas Collection & Sparging
Power Generation	Fly Ash Conveying & Aeration
Process Gas	Gas Boosting
Pulp & Paper	Chip Conveying & Process Vacuum
Resin & Plastic	Processing & Conveying
Soil Remediation	Vacuum Extraction & Sparging
Vacuum Excavation	Potholing & Slurry Recovery
Wastewater	Aeration & Backwashing

The above table illustrates industries which depend upon the Sutorbilt® Legend® to deliver clean, oil-free air to a wide range of global applications.

Legendary Design Features

1 High-strength impeller case is heavily ribbed and machined from a single piece of cast iron and features oversized dowel pins for precise mounting and alignment of head plates

- Results in reduced noise and more stable, vibration-free operation

2 Head plates, machined from cast iron, are ground on the interior surface to precise operating tolerances. Bearing fits are machined into head plates to assure exact bearing positioning

- Ensures accurate, fixed-dimension clearances through all blower operating conditions and temperature ranges

3 Impellers are machined from cast iron to an exact profile and are permanently fastened to steel shafts. They are dynamically balanced for smooth operation in any assembled position

- Provides extra strength and rigidity to handle continuous maximum loads without fatigue or deflection

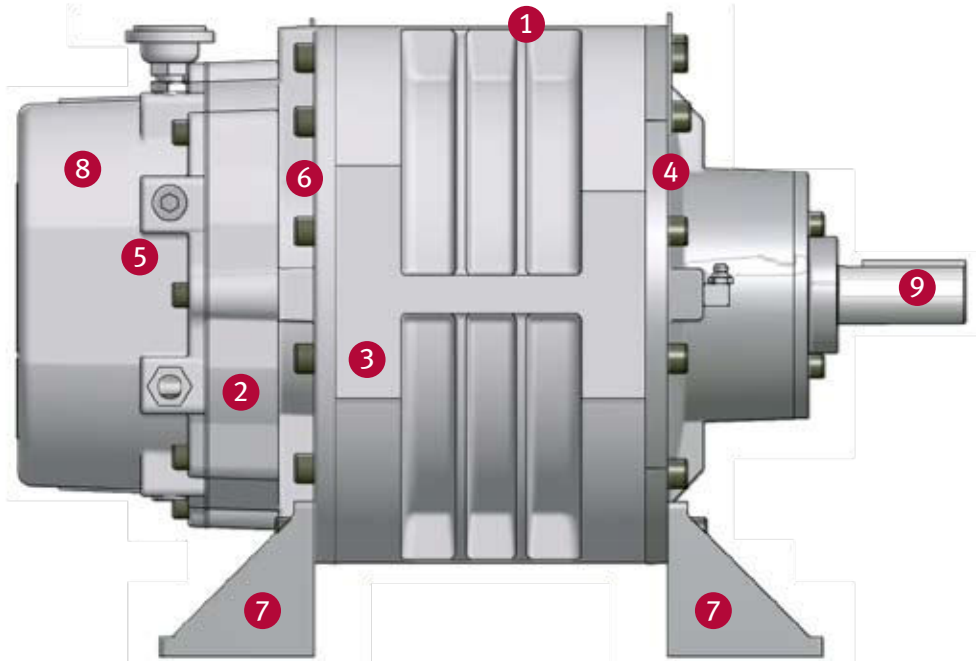

4 Anti-friction bearings are used exclusively (table at right)

- Optimum bearing selection provides longer blower life and added overhung shaft load capacity

Gear diameter	Single row ball	Double row ball	Cylindrical roller	Spherical roller
2"	•			
3-4"	•		•	
5"		•	•	
6-8"		•		•



2MP LHC

3MR RHC

4LVR BHC

5MR RHC

5 3–6" R versions feature improved timing and ease of teardown/rebuild through grip rings, which expand against the bore and compress on the shaft for a secure, mechanical shrink fit

2, 7 and 8" P versions feature precision machines alloy steel timing gears, permanently pinned to the shafts

- Assures non-slip timing even under the most strenuous loading conditions

6 High temperature Viton® oil seals

- Maximizes the seal life in continuous, severe-duty applications to provide leak-free operation

7 Flex-Mount™ design on 2, 7 and 8" blowers is adaptable to either vertical or horizontal installation, while 3–6" R-version blowers have universal feet

- The feet are precisely machined and match the footprints of many competitive units

8 Timing gears and gear end bearings are splash lubricated utilizing an abundant oil reservoir. A non-asbestos graphite gasketed, oil-tight housing encloses the timing gears. Drive end bearings are grease lubricated through fittings. Lip-type seals prevent oil and grease from entering the impeller chamber

- Superior gear and bearing lubrication is assured at all operating conditions with minimal maintenance

9 High strength steel drive shaft is extended for V-belt drive or direct connection

- Provides greater blower durability and installation flexibility

Available with Mechanical Gas Seals

The Legend design accommodates mechanical gas seals for critical gas applications with proven results based on a large installed base

- This field proven seal design allows trouble-free operation in critical gas applications

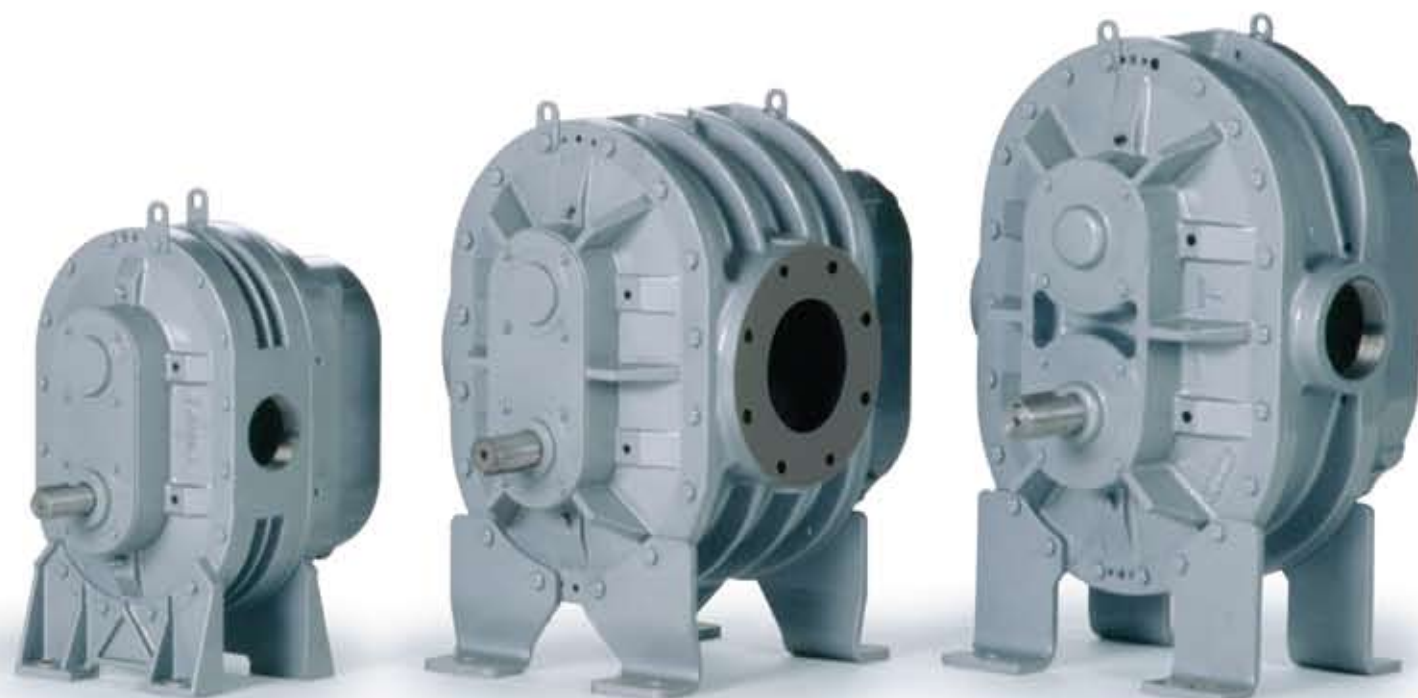

6HVR BHC

7MVP BHC

8HVP BHC

The Sutorbilt Legend Design

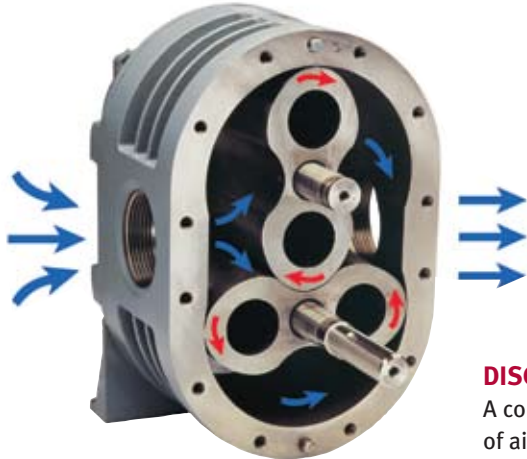

INTAKE

A constant volume of air or gas is drawn into the cylinder by the action of the turning impellers.

DISCHARGE

A constant volume of air or gas is forced out through the discharge port.

TRANSFER

A constant volume of trapped air or gas is transferred around the cylinder to the discharge port.

The Sutorbilt PD Cycle

- Two figure-eight impellers turn in opposite directions within a machined housing
- Transferring a constant volume of air or gas from inlet to discharge with every rotation of the blower drive shaft
- No lubrication within the cylinder is required
- Rotating components are held in close tolerance do not contact each other
- Impeller positioning is maintained by precision timing gears affixed to each impeller shaft
- Gear and bearing lubrication occurs externally to the cylinder assuring clean, oil-free gas delivery under all operating conditions

Universal Foot & Flex-Mount™ Design Provides Maximum Installation Versatility

- 3–6" R versions feature the "universal" mounting feet which allow them to be mounted in vertical and horizontal configurations
- 2", 7" & 8" P versions feature Flex-Mount™ design creating interchangeability on existing and new applications

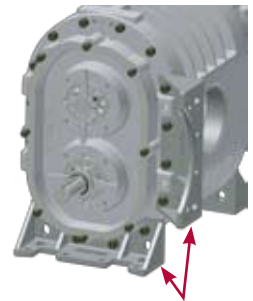

Universal Foot



Horizontal Configuration,
Right Hand Drive



Vertical Configuration,
Bottom Hand Drive



Horizontal Configuration,
Left Hand Drive



Vertical Configuration,
Top Hand Drive

State-of-the-Art Quality

The Gardner Denver line of Sutorbilt Legend blowers and vacuum pumps are engineered and manufactured under strict ISO 9001:2000 quality standards in our 330,000 square feet state-of-the-art facility in Sedalia, MO (photo below)

- Gardner Denver makes it a priority to invest in highly skilled people who take pride in producing quality products
- Our Flexible Machining System (FMS) assures consistent production of the highest quality Legend components
- Attention to detail is found throughout the manufacturing process such as utilizing advanced coordinate measuring equipment (photo A)
- Legend components are subjected to quality inspections before assembly
- Prior to shipment, every Legend is tested against rigid standards using our computer automated testing stations (photo B)

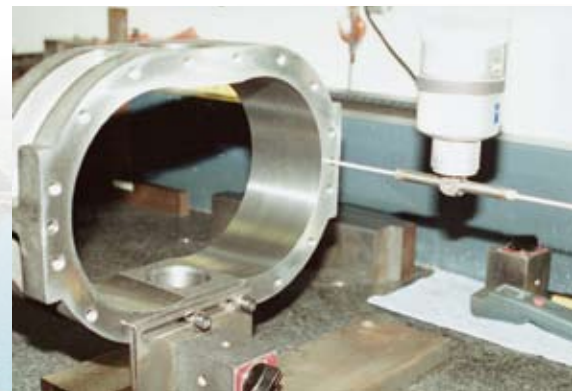

Photo A



Photo B



Sutorbilt Legend Pressure Performance Data

LOW PRESSURE UNITS	SIZE	DIA. INLET & OUTLET	DISPL. CU. FT./REV.	RPM	2 PSIG		3 PSIG		4 PSIG		5 PSIG		6 PSIG		7 PSIG	
					CFM	BHP	CFM	BHP	CFM	BHP	CFM	BHP	CFM	BHP	CFM	BHP
					2LP 2LVP	2"-S	0.035	2,800 3,250 3,560 5,275	76 91 102 162	1.1 1.3 1.4 2.0	71 86 97 157	1.6 1.8 2.0 2.8	67 82 93 153	2.1 2.4 2.6 3.7	63 79 89 149	2.5 2.9 3.2 4.6
3LR 3LVR	2½"-S	0.104	1,760 2,265 2,770 3,600	149 202 254 341	1.9 2.4 2.9 3.7	142 194 247 333	2.8 3.5 4.3 5.3	135 188 240 327	3.7 4.7 5.5 7.1	130 182 235 321	4.5 5.6 6.8 8.9	124 177 230 316	5.2 6.7 8.2 10.6	120 172 225 311	6.1 7.8 9.6 12.4	
4LR 4LVR	3"-S	0.170	1,760 2,190 2,620 3,600	253 326 400 566	3.0 3.7 4.4 5.8	243 316 389 556	4.5 5.3 6.3 8.7	234 307 381 547	5.7 7.1 8.4 11.6	227 300 373 539	7.1 8.8 10.6 14.5	220 293 366 533	8.5 10.6 12.7 17.4	213 286 360 526	9.9 12.4 14.8 20.3	
5LR 5LVR	4"-S	0.350	1,500 1,760 2,100 2,850	463 554 673 936	5.2 5.8 7.0 9.5	449 540 659 922	7.5 8.8 10.5 14.2	438 529 648 910	10.0 11.7 13.9 18.9	427 518 637 900	12.4 14.6 17.4 23.6	418 509 628 890	14.9 17.5 20.9 28.4	409 500 619 882	17.4 20.4 24.4 33.1	
6LR 6LVR	6"-F	0.718	1,170 1,760 1,930 2,350	739 1,162 1,284 1,586	8.0 12.0 13.1 16.0	716 1,139 1,261 1,563	11.9 18.0 19.7 24.0	697 1,120 1,242 1,544	15.9 24.0 26.3 32.0	680 1,103 1,225 1,527	19.9 29.9 32.8 40.0	664 1,088 1,210 1,512	23.9 35.9 39.4 48.0	650 1,074 1,196 1,497	27.9 41.9 46.0 56.0	
7LP 7LVP	8"-F	1.200	1,170 1,465 1,760 2,050	1,277 1,631 1,985 2,333	13.3 16.7 20.0 23.3	1,248 1,602 1,956 2,304	20.0 25.0 30.0 35.0	1,224 1,578 1,932 2,280	16.6 33.3 40.0 46.6	1,203 1,557 1,911 2,259	33.3 41.7 50.1 58.3	1,184 1,538 1,892 2,240	39.9 50.0 60.1 70.0			
8LP 8LVP	10"-F	1.740	880 1,170 1,375 1,800	1,366 1,871 2,228 2,967	14.5 19.3 22.7 29.7	1,329 1,834 2,191 2,930	21.8 28.9 34.0 44.5	1,298 1,803 2,159 2,899	29.0 38.6 45.4 59.4	1,271 1,775 2,132 2,871	36.3 48.2 56.7 74.2	1,246 1,750 2,107 2,847	43.5 57.9 68.0 89.1			

MEDIUM PRESSURE UNITS	SIZE	DIA. INLET & OUTLET	DISPL. CU. FT./REV.	RPM	7 PSIG		9 PSIG		10 PSIG		12 PSIG		13 PSIG		14 PSIG	
					CFM	BHP	CFM	BHP	CFM	BHP	CFM	BHP	CFM	BHP	CFM	BHP
					2MP 2MVP	1"-S	0.017	2,800 3,250 3,560 5,275	25 33 38 67	1.7 1.9 2.1 3.1	22 30 35 64	2.1 2.5 2.7 3.9	28 34 34 63	2.7 3.0 3.0 4.4		
3MR 3MVR	2"-S	0.060	1,760 2,265 2,770 3,600	64 95 125 175	3.6 4.6 5.5 7.2	59 89 119 169	4.6 5.8 7.1 9.2	87 117 117 167	6.4 7.9 7.9 10.2			112	9.5			
4MR 4MVR	2½"-S	0.117	1,760 2,190 2,620 3,600	144 194 245 359	6.8 8.5 10.2 14.0	136 186 236 351	8.8 10.9 13.1 18.0	132 182 233 347	9.8 12.1 14.5 20.0							
5MR 5MVR	4"-S	0.210	1,500 1,760 2,100 2,850	237 292 363 521	10.5 12.3 14.6 19.9	227 281 353 510	13.4 15.8 18.8 25.5	222 277 348 506	14.9 17.5 20.9 28.4	213 268 339 497	17.9 21.0 25.1 34.0	209 263 335 493	19.4 22.8 27.2 36.9			
6MR 6MVR	5"-S	0.383	1,170 1,760 1,930 2,350	332 558 622 784	14.9 22.4 24.5 29.9	316 542 607 768	19.1 28.8 31.5 38.4	309 535 600 761	21.2 32.0 35.0 42.7	296 522 587 748	25.5 38.3 42.0 51.2	289 515 580 741	27.6 41.5 45.5 55.5	283 509 574 735	29.7 44.7 49.1 59.7	
7MP 7MVP	6"-F	0.733	1,170 1,465 1,760 2,050	693 909 1,125 1,338	28.5 35.6 42.8 49.9	671 887 1,103 1,316	36.6 45.8 55.0 64.1	661 877 1,093 1,306	40.7 50.9 61.1 71.2							
8MP 8MVP	8"-F	1.040	880 1,170 1,375 1,800	709 1,011 1,224 1,666	30.4 40.4 47.4 62.1	681 983 1,196 1,638	39.0 51.9 61.0 79.9	669 970 1,183 1,625	43.4 57.7 67.8 88.7							

HIGH PRESSURE UNITS	SIZE	DIA. INLET & OUTLET	DISPL. CU. FT./REV.	RPM	7 PSIG		8 PSIG		9 PSIG		11 PSIG		13 PSIG		15 PSIG	
					CFM	BHP	CFM	BHP	CFM	BHP	CFM	BHP	CFM	BHP	CFM	BHP
					3HR 3HVR	1¼"-S	0.045	1,760 2,265 2,770 3,600	46 69 91 129	2.6 3.4 4.1 5.4	44 66 89 126	3.0 3.9 4.7 6.1	41 64 87 124	3.4 4.3 5.3 6.9		
4HR 4HVR	1½"-S	0.069	1,760 2,190 2,620 3,600	80 110 139 207	4.0 5.0 6.0 8.2	77 107 137 204	4.6 5.7 6.9 9.4	74 104 134 201	5.2 6.4 7.7 10.6			99 129 129 196	7.9 9.4 9.4 13.0			
5HR 5HVR	2½"-S	0.140	1,500 1,760 2,100 2,850	154 191 238 343	7.0 8.2 9.8 13.2	151 187 235 340	8.0 9.3 11.1 15.1	147 183 231 336	9.0 10.5 12.5 17.0			140 177 224 329	10.9 12.8 15.3 20.8			
6HR 6HVR	3"-S	0.227	1,170 1,760 1,930 2,350	188 321 360 455	8.8 13.3 14.5 17.7	182 316 355 450	10.1 15.1 16.6 20.2	177 311 350 445	11.3 17.0 18.7 22.8	168 302 340 436	13.8 20.8 22.8 27.8	159 293 332 427	16.4 24.6 27.0 32.9			
7HP 7HVP	4"-S	0.367	1,170 1,465 1,760 2,050	332 441 549 655	14.2 17.8 21.4 25.0	326 434 542 649	16.3 20.4 24.5 28.5	319 428 536 632	18.3 22.9 27.6 32.1	308 416 524 631	22.4 28.0 33.7 39.2	297 405 514 620	26.5 33.1 39.8 46.4	287 396 504 610	30.5 38.2 45.9 53.5	
8HP 8HVP	4"-S	0.566	880 1,170 1,375 1,800	363 528 644 884	16.5 22.0 25.8 33.8	354 518 634 875	18.9 25.1 29.5 38.6	345 509 626 866	21.2 28.3 33.2 43.5	329 493 609 850	26.0 34.5 40.6 53.1	315 479 595 835	30.7 40.8 48.0 62.8	301 465 581 822	35.4 47.1 55.3 72.4	

Performance based on inlet air at standard temperature of 68°F, an ambient pressure of 14.7 psia and 36% relative humidity. For performance at non-standard conditions, contact your authorized Gardner Denver representative. S=Screwed connections std. NPT. F=flange connections. Intake and outlet pipe connections are same type and size.

Sutorbilt Legend Vacuum Performance Data

LOW VACUUM UNITS	SIZE	DIA. INLET & OUTLET	DISPL. CU. FT./REV.	RPM	2 "Hg		4 "Hg		8 "Hg		10 "Hg		12 "Hg		14 "Hg	
					CFM	BHP	CFM	BHP	CFM	BHP	CFM	BHP	CFM	BHP	CFM	BHP
					2LP 2LVP	2"-S	0.035	2,800 3,250 3,560 4,165 5,275	82 98 108 130 168	0.7 0.7 0.8 0.9 1.1	74 90 101 122 161	1.1 1.3 1.4 1.6 1.9	61 77 88 109 148	2.0 2.3 2.5 2.9 3.6	55 71 82 103 142	2.5 2.8 3.1 3.6 4.5
3LR 3LVR	2½"-S	0.104	1,760 2,265 2,770 3,600	158 211 264 350	1.1 1.3 1.5 1.9	147 200 252 338	1.9 2.4 2.9 3.7	128 180 233 319	3.6 4.6 5.4 7.0	118 171 223 309	4.5 5.5 6.7 8.7	108 160 213 299	5.1 6.6 8.1 10.5	288	12.2	
4LR 4LVR	3"-S	0.170	1,760 2,190 2,620 3,600	266 339 412 579	2.6 1.9 2.3 3.1	459 323 396 563	5.1 3.7 4.3 5.7	424 297 370 537	9.8 6.9 8.3 11.4	406 284 357 524	12.2 8.7 10.4 14.3	388 270 343 510	14.7 10.4 12.4 17.1	329 495	14.5 20.0	
5LR 5LVR	4"-S	0.350	1,500 1,760 2,100 2,850	480 571 690 953	2.6 3.1 3.6 4.8	459 550 669 932	5.1 5.7 6.8 9.3	424 515 634 896	9.8 11.5 13.7 18.6	406 497 616 879	12.2 14.3 17.1 23.2	388 479 598 860	14.7 17.2 20.5 27.9	459 578 840	20.1 24.0 32.5	
6LR 6LVR	6"-F	0.718	1,170 1,760 1,930 2,350	766 1,190 1,312 1,614	4.1 5.9 6.5 7.9	732 1,115 1,278 1,579	7.8 11.8 12.9 15.7	674 1,097 1,219 1,521	15.7 23.5 25.8 31.4	645 1,068 1,191 1,492	19.6 29.4 32.3 39.3	615 1,038 1,160 1,462	23.5 35.3 38.7 47.2	1,005 1,127 1,429	41.2 45.2 55.0	
7LP 7LVP	8"-F	1.200	1,170 1,465 1,760 2,050	1,312 1,666 2,020 2,368	6.5 8.2 9.8 11.5	1,268 1,622 1,976 2,324	13.1 16.4 19.7 22.9	1,195 1,549 1,903 2,251	26.2 32.8 39.3 45.8	1,159 1,513 1,867 2,215	32.7 40.9 49.2 57.3	1,121 1,475 1,829 2,177	39.2 49.1 59.0 68.7			
8LP 8LVP	10"-F	1.740	880 1,170 1,375 1,800	1,411 1,916 2,273 3,012	7.1 9.5 11.1 14.6	1,355 1,860 2,217 2,953	14.3 19.0 22.3 29.2	1,261 1,766 2,122 2,862	28.5 37.9 44.6 58.4	1,214 1,719 2,076 2,815	35.7 47.4 55.7 72.9	1,165 1,670 2,026 2,765	42.8 56.9 66.9 87.6			

MEDIUM VACUUM UNITS	SIZE	DIA. INLET & OUTLET	DISPL. CU. FT./REV.	RPM	6 "Hg		10 "Hg		12 "Hg		14 "Hg		15 "Hg		16 "Hg	
					CFM	BHP	CFM	BHP	CFM	BHP	CFM	BHP	CFM	BHP	CFM	BHP
					2MP 2MVP	1"-S	0.017	2,800 3,250 3,560 4,165 5,275	31 39 44 54 73	0.8 0.9 0.9 1.1 1.4	24 32 37 48 67	1.2 1.4 1.5 1.7 2.2			34 44 44 63	1.8 2.1 2.6
3MR 3MVR	2"-S	0.060	1,760 2,265 2,770 3,600	76 106 136 186	1.6 2.0 2.4 3.1	63 93 124 174	2.6 3.3 4.0 5.0	57 87 117 167	3.1 3.9 4.7 6.0		110 160	5.4 7.0		156 7.5		
4MR 4MVR	2½"-S	0.117	1,760 2,190 2,620 3,600	161 211 262 376	3.0 3.7 4.4 5.9	142 193 243 358	4.9 6.0 7.1 9.8	132 183 233 348	5.8 7.2 8.6 11.8		222 337	10.0 13.7	331	14.7	325 15.7	
5MR 5MVR	4"-S	0.210	1,500 1,760 2,100 2,850	258 313 384 542	4.5 5.2 6.2 8.4	235 290 361 519	7.3 8.6 10.3 13.9	223 277 349 506	8.8 10.3 12.3 16.7		209 264 335 493	10.3 12.1 14.4 19.5	328 485	15.4 20.9	477 22.3	
6MR 6MVR	5"-S	0.383	1,170 1,760 1,930 2,350	363 589 655 815	6.3 9.4 10.3 12.6	328 554 619 780	10.4 15.7 17.2 21.0	310 536 601 762	12.5 18.8 20.7 25.2		290 516 581 741	14.6 22.0 24.1 29.3	279 505 570 731	15.7 23.5 25.8 31.4	267 493 558 719	16.7 25.1 27.5 33.5
7MP 7MVP	6"-F	0.733	1,170 1,465 1,760 2,050	738 954 1,170 1,383	12.0 15.0 18.0 21.0	688 904 1,121 1,333	20.0 25.0 30.0 35.0	662 878 1,094 1,307	24.0 30.0 36.1 42.0	633 850 1,065 1,278	28.0 35.0 42.1 49.0	618 834 1,050 1,263	30.0 37.5 45.1 52.5	601 817 1,034 1,246	32.0 40.0 48.1 56.0	
8MP 8MVP	8"-F	1.040	880 1,170 1,375 1,800	765 1,067 1,280 1,722	12.8 17.0 20.0 26.2	703 1,005 1,218 1,660	21.3 28.3 33.3 43.6	670 972 1,185 1,627	25.6 34.0 40.0 52.3	634 936 1,149 1,591	29.8 39.7 46.6 61.0	615 917 1,130 1,572	32.0 42.5 50.0 65.4	594 896 1,109 1,551	34.1 45.3 53.3 69.7	

HIGH VACUUM UNITS	SIZE	DIA. INLET & OUTLET	DISPL. CU. FT./REV.	RPM	6 "Hg		8 "Hg		12 "Hg		14 "Hg		15 "Hg		16 "Hg	
					CFM	BHP	CFM	BHP	CFM	BHP	CFM	BHP	CFM	BHP	CFM	BHP
					3HR 3HVR	1¼"-S	0.045	1,760 2,265 2,770 3,600	55 78 100 138	1.1 1.4 1.7 2.3	50 73 95 133	1.5 1.9 2.3 3.0	40 62 85 122	2.2 2.8 3.5 4.5		79 117
4HR 4HVR	1½"-S	0.069	1,760 2,190 2,620 3,600	91 121 151 218	1.7 2.1 2.5 3.5	85 115 144 212	2.3 2.8 3.4 4.6	72 102 132 199	3.4 4.2 5.1 6.9		95 124 192	4.9 5.9 8.1	91 120 188	5.3 6.3 8.7	184 9.3	
5HR 5HVR	2½"-S	0.140	1,500 1,760 2,100 2,850	170 206 254 359	2.9 3.4 4.1 5.6	161 198 245 350	3.9 4.6 5.5 7.4	144 180 228 333	5.9 6.9 8.2 11.2		134 171 218 323	6.8 8.0 9.6 13.0	165 213 318	8.6 10.3 14.0	312 14.9	
6HR 6HVR	3"-S	0.227	1,170 1,760 1,930 2,350	209 343 381 477	3.7 5.6 6.1 7.5	197 331 370 441	4.8 7.4 8.2 9.9	173 307 345 441	7.4 11.2 12.2 14.9		159 293 332 427	8.7 13.0 14.3 17.4	152 286 325 420	9.3 14.0 15.3 18.6	278 317 412	14.9 16.3 19.9
7HP 7HVP	4"-S	0.367	1,170 1,465 1,760 2,050	359 467 575 682	6.0 7.5 9.0 10.5	344 453 561 667	8.0 10.0 12.0 14.0	314 422 531 637	12.0 15.0 18.1 21.0	297 406 514 620	14.0 17.5 21.1 24.5	288 396 505 611	15.0 18.8 22.6 26.3	278 387 495 601	16.0 20.0 24.1 28.0	
8HP 8HVP	4"-S	0.566	880 1,170 1,375 1,800	400 564 680 921	7.0 9.3 10.9 14.2	380 544 660 901	9.3 12.3 14.5 19.0	338 502 618 859	13.9 18.5 21.7 28.5	315 479 595 835	16.2 21.6 25.4 33.2	302 466 582 823	17.4 23.1 27.2 35.6	453 569 809	24.7 29.0 38.0	

Sutorbilt Legend Dimensional Data

Horizontal Configurations

SIZE	WT.	CONN.	A	B	C	D	E	F	G	H	J	K	L	M	N	O	P	R	S	T	U
2M	72	S	5.00	2.00	2.00	6.36	3.25	3.75	2.75	7.00	9.25	1.00	5.16	10.00	2.76	1.97	1.62	0.19	0.620	0.13	0.44
2L	86	S	7.00	3.00	2.00	6.36	3.25	3.75	2.75	7.00	9.25	2.00	6.16	12.00	4.76	1.97	1.62	0.19	0.620	0.13	0.44
3H	88	S	6.75	2.69	2.68	7.75	3.88	5.00	3.50	8.88	11.26	1.25	5.86	12.05	3.50	2.05	1.62	0.19	0.750	0.25	0.62 x 1.12
3M	110	S	7.62	3.13	2.68	7.75	3.88	5.00	3.50	8.88	11.26	2.00	6.30	12.92	4.38	2.05	1.62	0.19	0.750	0.25	0.62 x 1.12
3L	132	S	10.25	4.44	2.68	7.75	3.88	5.00	3.50	8.88	11.26	2.50	7.61	15.55	7.00	2.05	1.62	0.19	0.750	0.25	0.62 x 1.13
4H	138	S	7.24	3.00	3.00	8.25	4.19	6.25	4.00	10.44	12.38	1.50	6.91	13.74	4.00	2.39	1.62	0.19	0.875	0.38	0.5 x 0.75
4M	160	S	9.49	4.13	3.00	8.25	4.19	6.25	4.00	10.44	12.38	2.50	8.04	15.99	6.26	2.39	1.62	0.19	0.875	0.38	0.5 x 0.75
4L	182	S	11.99	5.38	3.00	8.25	4.19	6.25	4.00	10.44	12.38	3.00	9.29	18.49	8.76	2.39	1.62	0.19	0.875	0.38	0.5 x 0.75
5H	210	S	10.85	3.50	3.50	9.00	5.19	7.00	5.00	12.19	15.38	2.50	8.19	16.38	4.86	2.50	2.00	0.25	1.125	0.38	0.56 x 0.75
5M	232	S	12.85	4.50	3.50	9.00	5.19	7.00	5.00	12.19	15.38	4.00	9.19	18.38	6.86	2.50	2.00	0.25	1.125	0.38	0.56 x 0.75
5L	306	S	16.85	6.50	3.50	9.00	5.19	7.00	5.00	12.19	15.38	4.00	11.19	22.38	10.86	2.50	2.00	0.25	1.125	0.38	0.56 x 0.75
6H	318	S	9.76	3.94	4.00	16.50	6.00	8.75	6.00	14.75	18.00	3.00	9.18	18.57	5.76	2.94	2.00	0.31	1.375	0.50	0.75 x 1
6M	366	S	13.00	5.56	4.00	16.50	6.19	8.75	6.00	14.94	18.00	5.00	10.80	21.81	9.00	2.94	2.00	0.31	1.375	0.50	0.75 x 1
6L	538	F	20.00	9.06	4.00	16.50	7.50	8.75	6.00	16.25	18.00	6.00	14.31	28.82	16.00	2.94	2.00	0.31	1.375	0.50	0.75 x 1
7H	482	S	12.00	4.63	5.50	15.00	9.69	11.00	7.00	20.69	22.00	4.00	10.00	21.03	5.74	3.21	2.50	0.38	1.562	0.50	0.75 x 1
7M	638	F	17.50	7.38	5.50	15.00	8.50	11.00	7.00	19.50	22.00	6.00	12.75	26.53	11.24	3.21	2.50	0.38	1.562	0.50	0.75 x 1
7L	770	F	24.50	10.88	5.50	15.00	8.50	11.00	7.00	19.50	22.00	8.00	16.25	33.53	18.24	3.21	2.50	0.38	1.562	0.50	0.75 x 1
8H	736	S	13.50	5.75	6.00	16.00	10.00	12.50	8.00	22.50	25.25	4.00	11.69	23.85	7.76	3.86	2.50	0.38	1.750	0.50	0.75 x 1
8M	938	F	19.00	8.50	6.00	16.00	10.00	12.50	8.00	22.50	25.25	8.00	14.44	29.35	13.26	3.86	2.50	0.38	1.750	0.50	0.75 x 1
8L	1,170	F	27.00	12.50	6.00	16.00	10.00	12.50	8.00	22.50	25.25	10.00	18.44	37.35	21.26	3.86	2.50	0.38	1.750	0.50	0.75 x 1

S=Threaded connections standard NPT. F=flange connections. Inlet and outlet connections are the same type and size. Dimensions are in inches. Weights are in pounds and include shipping cartons or pallets and are approximate.

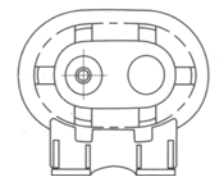
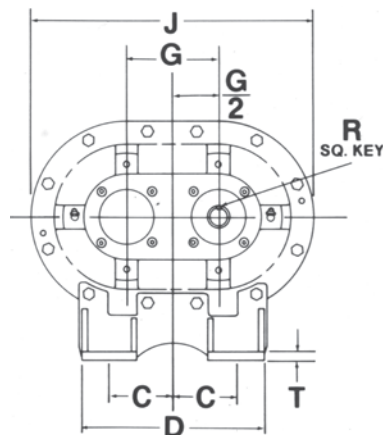
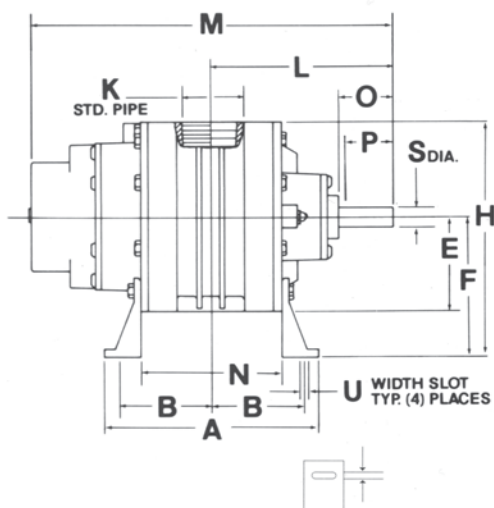

LHC
LEFT HAND CENTRAL
(OPTIONAL ASSEMBLY)

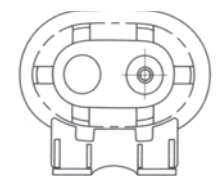

RHC
RIGHT HAND CENTRAL
(STANDARD ASSEMBLY)
CENTER TIMED FOR ROTATION
IN EITHER DIRECTION

Vertical Configurations

SIZE	WT.	CONN.	A	B	C	D	E	F	G	H	J	K	L	M	N	O	P	R	S	T	U
2MV	72	S	5.00	2.00	1.50	5.60	3.50	4.88	6.25	9.50	6.50	1.00	5.16	10.00	2.76	1.97	1.62	0.19	0.6200	0.13	0.44
2LV	86	S	7.00	3.00	1.50	5.60	3.50	4.88	6.25	9.50	6.50	2.00	6.16	12.00	4.76	1.97	1.62	0.19	0.6200	0.13	0.44
3HV	88	S	6.75	2.69	2.68	7.75	4.50	6.25	8.00	11.88	7.76	1.25	5.86	12.05	3.50	2.05	1.62	0.19	0.7500	0.25	0.62 x 1.12
3MV	110	S	7.62	3.13	2.68	7.75	4.50	6.25	8.00	11.88	7.76	2.00	6.30	12.92	4.36	2.05	1.62	0.19	0.7500	0.25	0.62 x 1.12
3LV	132	S	10.25	4.44	2.68	7.75	4.50	6.25	8.00	11.88	7.76	2.50	7.61	15.55	7.00	2.05	1.62	0.19	0.7500	0.25	0.62 x 1.12
4HV	138	S	7.24	3.00	3.00	8.25	4.50	6.50	8.50	12.69	8.40	1.50	6.91	13.74	4.00	2.39	1.62	0.19	0.8750	0.38	0.5 x 0.75
4MV	160	S	9.49	4.13	3.00	8.25	4.50	6.50	8.50	12.69	8.40	2.50	8.04	15.99	6.26	2.39	1.62	0.19	0.8750	0.38	0.5 x 0.75
4LV	182	S	11.99	5.38	3.00	8.25	4.50	6.50	8.50	12.69	8.40	3.00	9.29	18.49	8.76	2.39	1.62	0.19	0.8750	0.38	0.5 x 0.75
5HV	210	S	10.85	3.50	3.50	9.00	5.50	8.00	10.50	15.85	10.38	2.50	8.19	16.38	4.86	2.50	2.00	0.25	1.1250	0.38	0.56 x 0.75
5MV	232	S	12.85	4.50	3.50	9.00	5.50	8.00	10.50	15.85	10.38	4.00	9.19	18.38	6.86	2.50	2.00	0.25	1.1250	0.38	0.56 x 0.75
5LV	306	S	16.85	6.50	3.50	9.00	5.50	8.00	10.50	15.85	10.38	4.00	11.19	22.38	10.86	2.50	2.00	0.25	1.1250	0.38	0.56 x 0.75
6HV	318	S	9.76	3.94	4.00	10.50	8.75	11.75	14.75	20.75	12.00	3.00	9.18	18.57	5.76	2.94	2.00	0.31	1.3750	0.50	0.75 x 1
6MV	366	S	13.00	5.56	4.00	10.50	8.75	11.75	14.75	20.80	12.38	5.00	10.80	21.81	9.00	2.94	2.00	0.31	1.3750	0.50	0.75 x 1
6LV	538	F	20.00	9.06	4.00	10.50	8.75	11.75	14.75	20.75	15.00	6.00	14.31	28.81	9.00	2.93	2.00	0.31	1.3750	0.50	0.75 x 1
7HV	482	S	12.00	4.62	5.50	14.04	11.00	14.50	18.00	25.50	19.38	4.00	10.00	21.03	5.74	3.21	2.50	0.38	1.5620	0.50	0.75 x 1
7MV	638	F	17.50	7.37	5.50	14.04	11.00	14.50	18.00	25.50	17.00	6.00	12.75	26.53	11.24	3.21	2.50	0.38	1.5620	0.50	0.75 x 1
7LV	770	F	24.50	10.87	5.50	14.04	11.00	14.50	18.00	25.50	17.00	8.00	16.25	33.53	18.24	3.21	2.50	0.38	1.5620	0.50	0.75 x 1
8HV	736	S	13.50	5.75	6.00	16.00	12.50	16.50	20.50	29.12	20.00	4.00	11.69	23.85	7.76	3.86	2.50	0.38	1.7500	0.50	0.75 x 1
8MV	938	F	19.00	8.50	6.00	16.00	12.50	16.50	20.50	29.12	20.00	8.00	14.44	29.35	13.26	3.86	2.50	0.38	1.7500	0.50	0.75 x 1
8LV	1,170	F	27.00	12.50	6.00	16.00	12.50	16.50	20.50	29.12	20.00	10.00	18.44	37.35	21.26	3.86	2.50	0.38	1.7500	0.50	0.75 x 1

S=Threaded connections standard NPT. F=flange connections. Inlet and outlet connections are the same type and size. Dimensions are in inches. Weights are in pounds and include shipping cartons or pallets and are approximate.

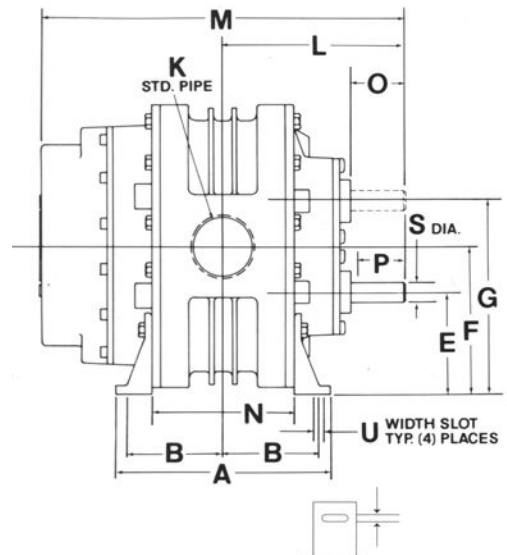
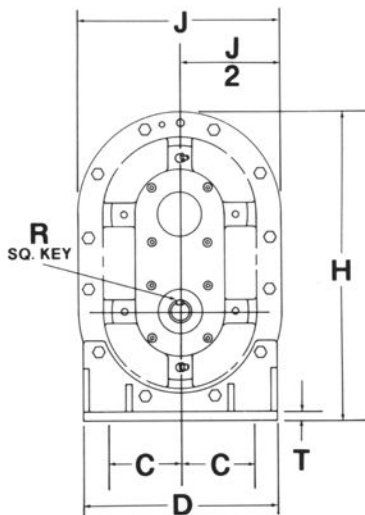
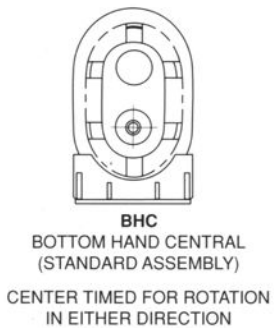
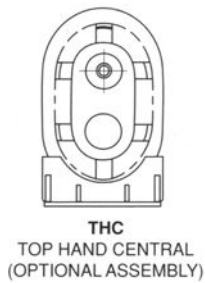

Genuine Gardner Denver Parts & Lubricants

- Maintain the Gardner Denver performance advantage and reliability with Genuine GD Replacement Parts available through authorized sales and service representatives
- Protect your Gardner Denver investment with AEON® PD, the only lubricant specially formulated for all blowers in any environment
 - Now available:
 - » AEON® PD-XD (eXtreme Duty)
 - » Designed specifically for high ambient and high discharge temperature applications
 - Also available:
 - » AEON® PD (standard applications)
 - » AEON® PD-FG (Food Grade)



Retain your Gardner Denver advantage with Genuine Replacement Parts

- Replacement parts incorporate the most recent design upgrades
- All parts meet original manufacturing specifications and tolerances for guaranteed fit and function
- Pre-packaged overhaul kits with detailed service manuals are available from your local authorized Gardner Denver distributor



Gardner Denver®

www.GardnerDenverProducts.com pd.blowers@gardnerdenver.com

Gardner Denver, Inc. 1800 Gardner Expressway, Quincy, IL 62305
Telephone: (800) 682-9868 FAX: (217) 221-8780

©2009 Gardner Denver, Inc. Printed in U.S.A. PD-SB-L 4th Ed. 10/09



Please recycle after use.

